

DataLink 500A

Category 6A 8P8C RJ45 Unshielded Tool-Less 90° Keystone Jacks
J6A-00856

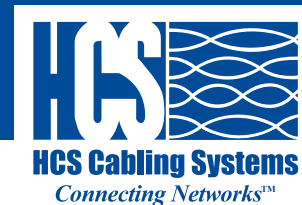

Installation Manual

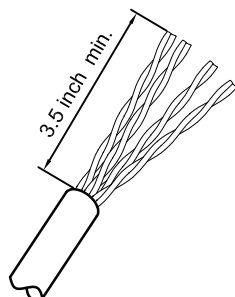

STEP 1:
Strip off at least 3.5 inch of jacket from end of cable.

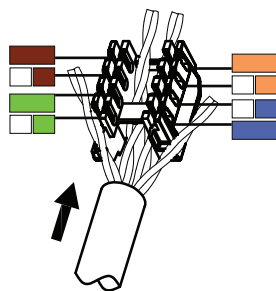

STEP 2:
Insert wire pairs into the correct positions (T568A/568B).

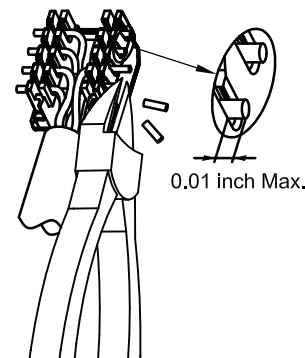
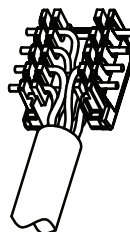

STEP 3:
The tips of the wires should be no more than 0.01 inch.

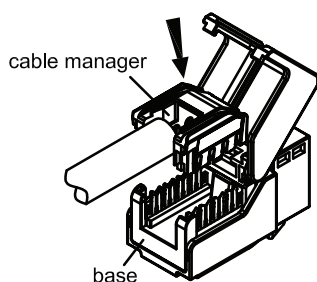

STEP 4:
Install cable manager on base. Be sure they snap together completely.

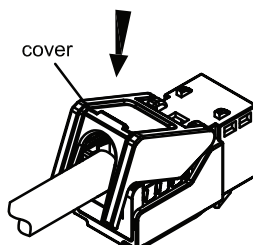

STEP 5:
Lock the cover on the base.

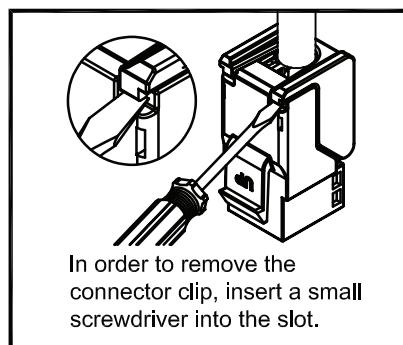

In order to remove the connector clip, insert a small screwdriver into the slot.